

Graph Comparisons: use the information provided in one graph to complete the other two graphs. Be aware that some graphs may be unrealistic, and some may have multiple correct solutions.

1.

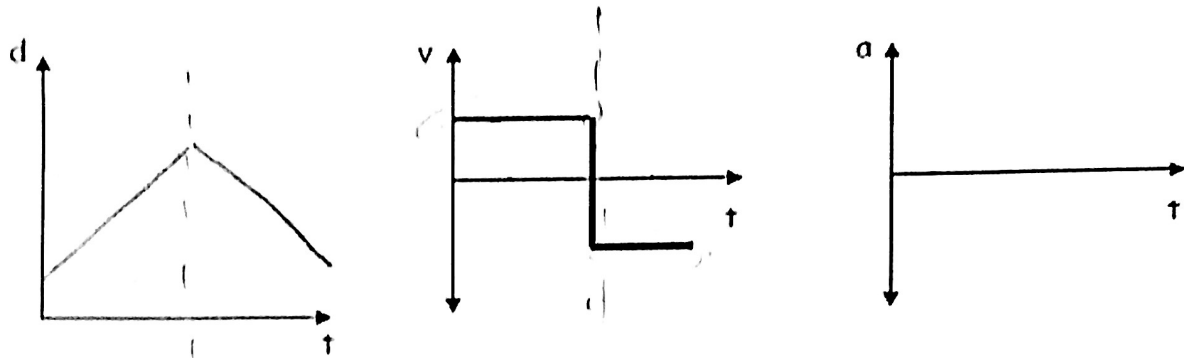

2.

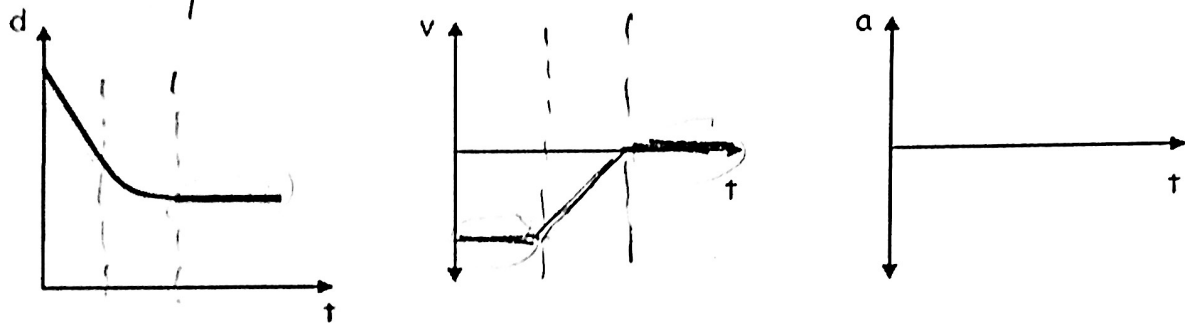

3.

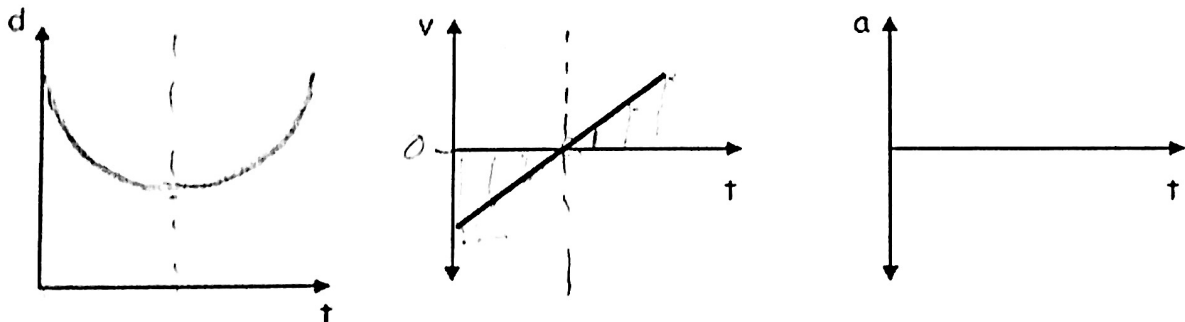

4.

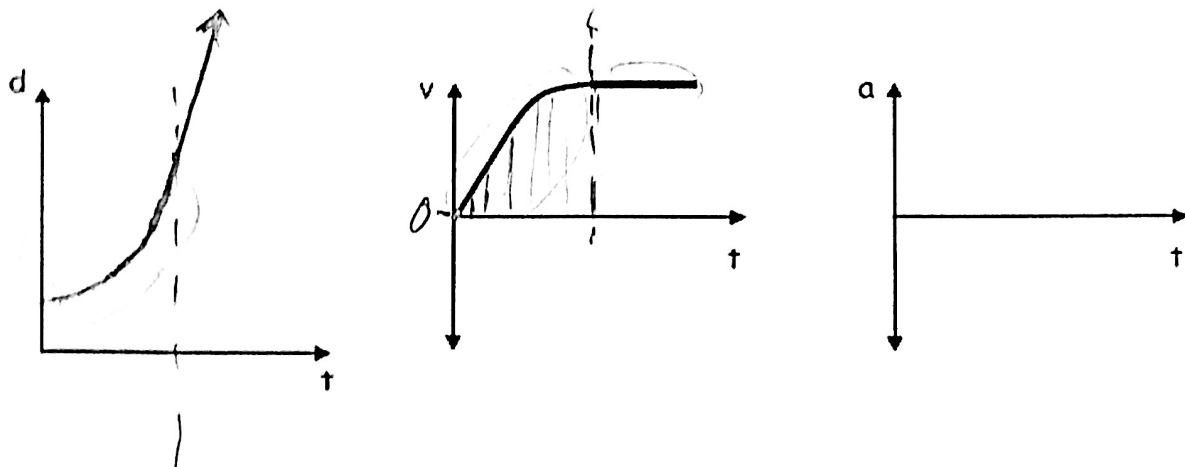

5.

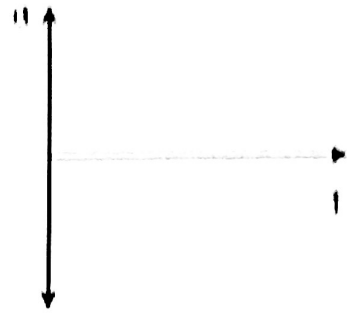
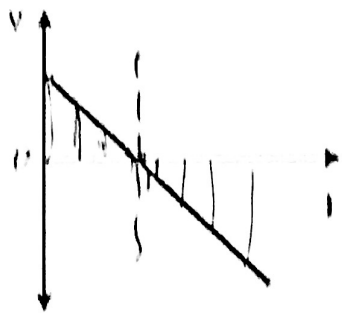
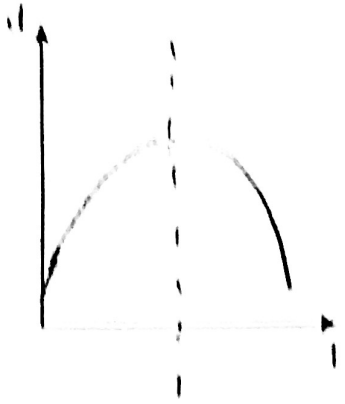

6.

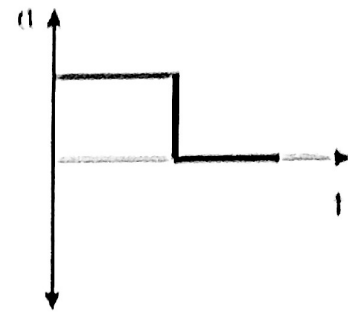
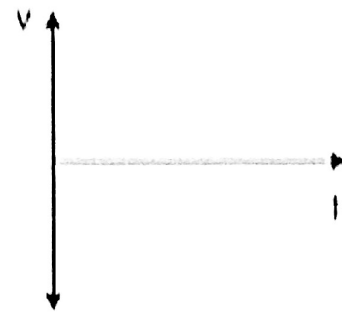
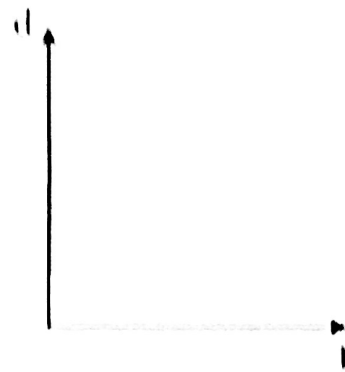

7.

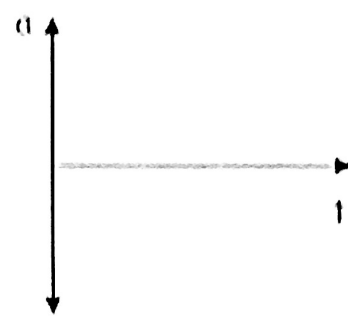
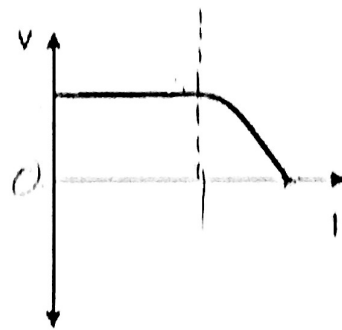
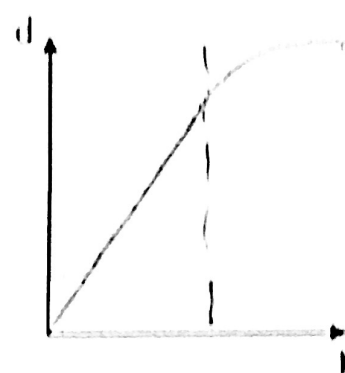

8.

